

A-TRACK HOUSING FAMILY

Semi-Custom to Meet Your Needs



DIM TO GLOW™
Dynamic White



Semi-Custom

Offered in a variety of shapes and sizes and endless customizable options

End to End Connectivity

Using our patent pending coupling mounting clips, A-Track offers an elegant solution no matter how short or long your fixture needs to be

Made in the USA

Fabricated of high quality American aluminum and premium optic diffuser lenses

Custom Lengths

Pre-assembled: ≤ 8 ft (96 in)
Assembly Required: > 8 ft (96 in)

See separate installation instructions

Patent Pending - MADE IN USA

Tested as suitable for use within clothing closet spaces by ETL/Intertek

Must be installed in accordance with NEC 410.16 for use in clothing closet spaces



Component of a complete system including: Aion LED A-Track Light Engine, Aion LED A-Track housing with diffuser lens, & Aion LED driver (power supply). Dimmer not included. Approved dimmers, controls, power supplies, cable, & other components only. Contact Aion LED for questions regarding compatibility. Electrician installed. Strictly adhere to NEC & local building code. Limited 5-year warranty against manufacturing defects only, does not cover labor; voided by: inadequate ventilation, field modifications, installation by unqualified personnel, unapproved controls, drivers, cabling, other devices, not following installation guidelines & protocol, general negligence. Installer assumes all liability with regard to property & safety. This product is UL listed. See separate "Aion LED Warranty Terms" & additional instructional materials for more information. Authorized installers only. Systems tested prior to shipping.

Customization Options

AT-Series A-Track fixtures are semi custom and made to order. If you need an additional option or feature- please contact Aion LED to discuss

Profile

Standard
Deep
45° Asymmetrical

Lens

Frosted
Clear
Prismatic

Finish

Anodized Silver
Anodized Dark Bronze
Custom Color

Mounting

Mounting Clips
Pivot Mounting Clips
HD Adhesive backing

Feed

End
Rear
Side

Length

Custom pre-cut
Field Cuttable

Wiring

24" Leads
48" Leads
Custom length leads
M/F Disconnect Plugs
Color: White/ Black

AT Series A-Track orders include: A -Track housing, lens, end caps, end cap screws, wire grommets & mounting clips

Tested as suitable for use within clothing closet spaces by ETL/ Intertek

Must be installed in accordance with NEC 410.16 for use in clothing closet spaces



Component of a complete system including: Aion LED A-Track Light Engine, Aion LED A-Track housing with diffuser lens, & Aion LED driver (power supply). Dimmer not included. Approved dimmers, controls, power supplies, cable, & other components only. Contact Aion LED for questions regarding compatibility. Electrician installed. Strictly adhere to NEC & local building code. Limited 5-year warranty against manufacturing defects only, does not cover labor; voided by: inadequate ventilation, field modifications, installation by unqualified personnel, unapproved controls, drivers, cabling, other devices, not following installation guidelines & protocol, general negligence. Installer assumes all liability with regard to property & safety. This product is UL listed. See separate "Aion LED Warranty Terms" & additional instructional materials for more information. Authorized installers only. Systems tested prior to shipping.



AT801
Standard Profile

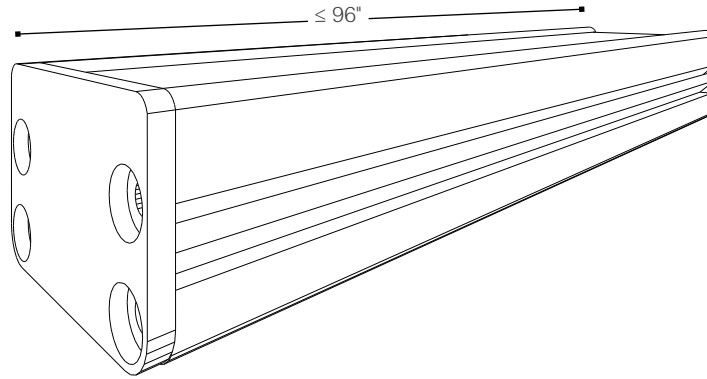

NOT TO SCALE

Dimensions

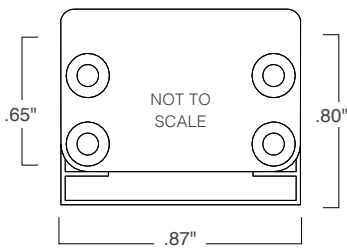

Accessories

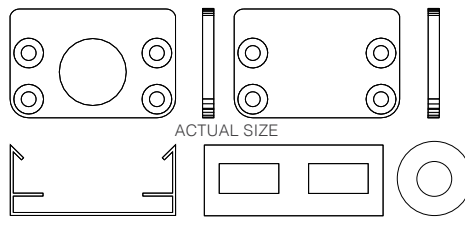

Compatibility

Direct View	Indirect View
None	8924-CT3022-LE

AT802
Deep Profile

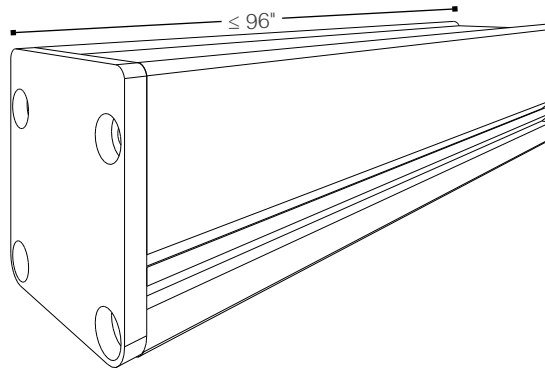

NOT TO SCALE

Dimensions

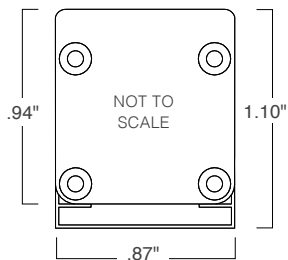

Accessories

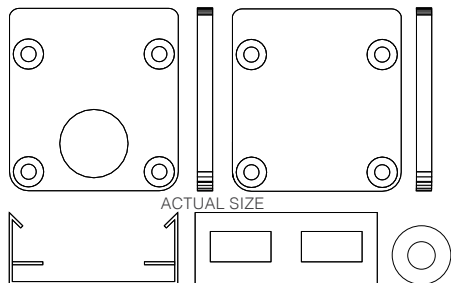

Compatibility

Direct View	Indirect View
8924-CT3022-LE	8924-CT3022-LE

Component of a complete system including: Aion LED A-Track Light Engine, Aion LED A-Track housing with diffuser lens, & Aion LED driver (power supply). Dimmer not included. Approved dimmers, controls, power supplies, cable, & other components only. Contact Aion LED for questions regarding compatibility. Electrician installed. Strictly adhere to NEC & local building code. Limited 5-year warranty against manufacturing defects only, does not cover labor; voided by: inadequate ventilation, field modifications, installation by unqualified personnel, unapproved controls, drivers, cabling, other devices, not following installation guidelines & protocol, general negligence. Installer assumes all liability with regard to property & safety. This product is UL listed. See separate "Aion LED Warranty Terms" & additional instructional materials for more information. Authorized installers only. Systems tested prior to shipping.

AT845

45° Asymmetrical Angle Profile

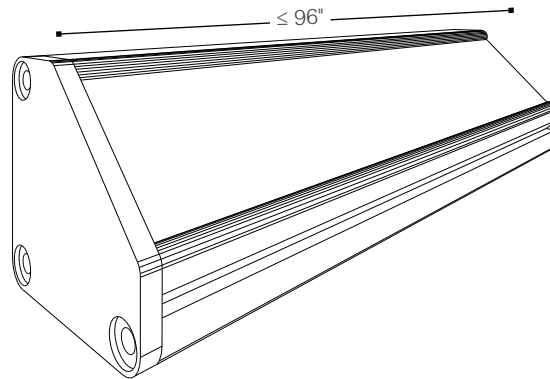

NOT TO SCALE

Dimensions

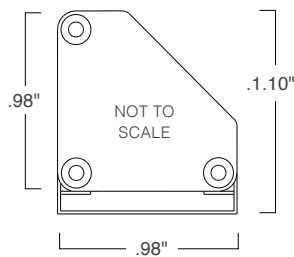

Accessories

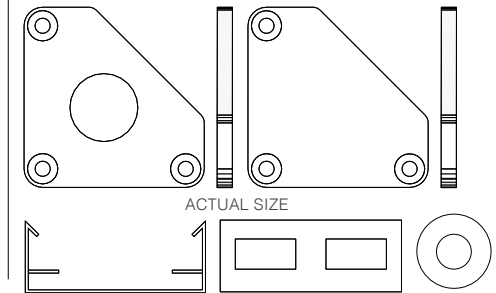

Compatibility

Direct View	Indirect View
None	8924-CT3022-LE

Power Leads & Plugs Orientation Options

If an orientation isn't selected, AT845 Fixtures will be delivered unassembled

OPTION A

OPTION B

Down, Left

Up, Right

Up, Left

Down, Right

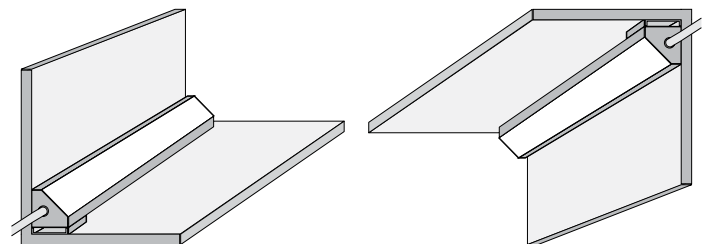
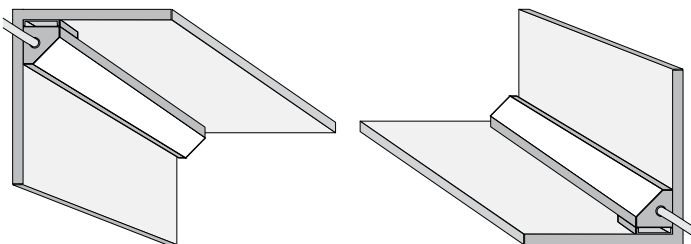

Component of a complete system including: Aion LED A-Track Light Engine, Aion LED A-Track housing with diffuser lens, & Aion LED driver (power supply). Dimmer not included. Approved dimmers, controls, power supplies, cable, & other components only. Contact Aion LED for questions regarding compatibility. Electrician installed. Strictly adhere to NEC & local building code. Limited 5-year warranty against manufacturing defects only, does not cover labor; voided by: inadequate ventilation, field modifications, installation by unqualified personnel, unapproved controls, drivers, cabling, other devices, not following installation guidelines & protocol, general negligence. Installer assumes all liability with regard to property & safety. This product is UL listed. See separate "Aion LED Warranty Terms" & additional instructional materials for more information. Authorized installers only. Systems tested prior to shipping.

Aion LED lenses are UV stabilized and won't yellow in direct sunlight.

Frosted

Widest Angle
Mid-Transmittance
100% Diffusion

See direct view for compatible light engines

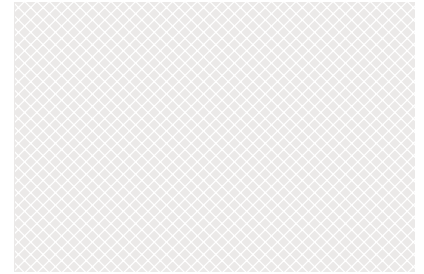
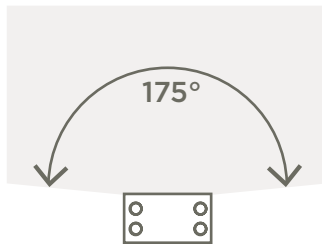

Prismatic

Wider Angle
High Transmittance
Mid Range Diffusion

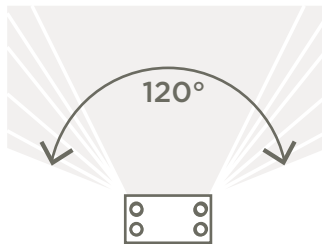

Clear

Wide Angle
Maximum Transmittance
Zero Diffusion

Clear lens is recommended for indirect applications.

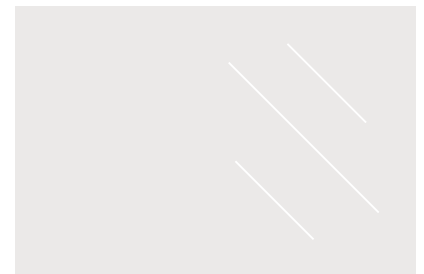
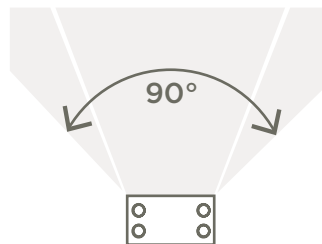

High Rendering Warm White
Dynamic White



22 2150K • 95+ CRI

24 2350K • 95+ CRI

27 2650K • 95+ CRI

30 2950K • 95+ CRI



DIM TO GLOW™

UL Class 2

IP20 Dry Location

Custom Cut To Fit

50,000 Hour Minimum
Lifespan

Requires: Aion LED Driver, Approved Controller, AT, WT or ST Series Housing -Sold Separately, Not Included

Tested as suitable for use within clothing closet spaces by ETL/ Intertek

Must be installed in accordance with NEC 410.16 for use in clothing closet spaces



Component of a complete system including: Aion LED A-Track Light Engine, Aion LED A-Track housing with diffuser lens, & Aion LED driver (power supply). Dimmer not included. Approved dimmers, controls, power supplies, cable, & other components only. Contact Aion LED for questions regarding compatibility. Electrician installed. Strictly adhere to NEC & local building code. Limited 5-year warranty against manufacturing defects only, does not cover labor; voided by: inadequate ventilation, field modifications, installation by unqualified personnel, unapproved controls, drivers, cabling, other devices, not following installation guidelines & protocol, general negligence. Installer assumes all liability with regard to property & safety. This product is UL listed. See separate "Aion LED Warranty Terms" & additional instructional materials for more information. Authorized installers only. Systems tested prior to shipping.

8924-CT3022-LE
High Rendering Warm White Light Engine

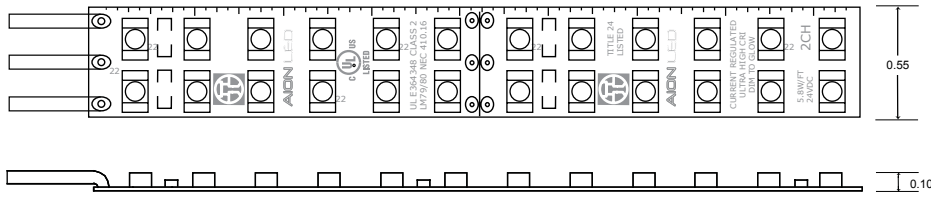

UL Class 2
IP20 Dry Location
Custom Cut To Fit
50,000 Hour Minimum
Lifespan

2 Channel Fixture
CH 1: 3000K ~2.8W/ft.
CH 2: 2150K ~2.8W/ft.
MIN. Increment: 2 in.
MAX. Increment: (2x) 8ft.*,
16ft.**

PHOTOMETRICS PER CHANNEL	@2150K	@2950K
Total Lumens	126.64	206.60
Input Power (W)	2.26	2.82
Efficacy	56.80	79
Color Rendering Index (CRI)	94	92
R9	71.30	68.06
Input Voltage (VDC)	24.00	
Input Current (Amp)	0.09	0.11
Correlated Color Temperature (K)	2170	2958
Rated Lifetime	50,000 Hours	

REQUIRES D100-X2 DRIVER, DMX CONTROLLER AND 800-SERIES HOUSING -Sold Separately, Not Included

Component of a complete system including: Aion LED A-Track Light Engine, Aion LED A-Track housing with diffuser lens, & Aion LED driver (power supply). Dimmer not included. Approved dimmers, controls, power supplies, cable, & other components only. Contact Aion LED for questions regarding compatibility. Electrician installed. Strictly adhere to NEC & local building code. Limited 5-year warranty against manufacturing defects only, does not cover labor; voided by: inadequate ventilation, field modifications, installation by unqualified personnel, unapproved controls, drivers, cabling, other devices, not following installation guidelines & protocol, general negligence. Installer assumes all liability with regard to property & safety. This product is UL listed. See separate "Aion LED Warranty Terms" & additional instructional materials for more information. Authorized installers only. Systems tested prior to shipping.

X2
2 Channel DMX Driver

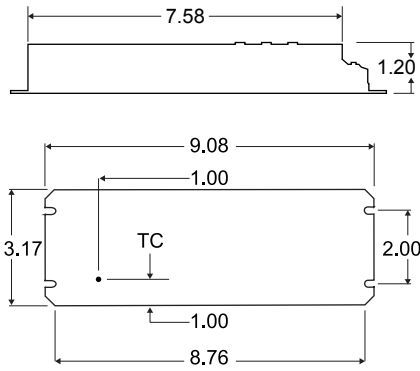
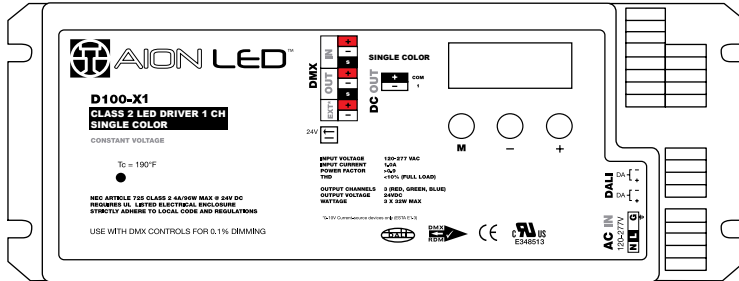

2 Channel DMX Driver
Integrated Class 2 Supply

LCD interface

Universal 100-277VAC Input

UL, CE, & CSA APPROVED

Requires UL Listed Enclosure

MODEL	D100-X2		
CASE	DRY & DAMP	DIMENSIONS (L-W-H)"	9.06 x 3.15 x 1.18"
WATTAGE	96W @ 24 VDC	PRIMARY BREAKER	AUTO-RESET
INPUT VOLTAGE (Hz)	100-277 VAC, 60HZ	DIMMING	0.1%
INRUSH CURRENT	120 VAC: 35A 240μs 277 VAC: 75A 240μs	CONTROL TYPE	Aion LED AX5-2 Controller or 3rd Party DMX Interface
INPUT CURRENT	120 VAC: 1.05A 277 VAC: 0.45A	3RD PARTY DMX COMPATIBILITY	Lutron, Vantage, Crestron, ETC AMX (ANY DMX)
POWER FACTOR	>0.94	THERMAL CLASS	(B) 130 C
VOLTAGE LOADED	23.5 VDC	MAX FEET 8924-CT3022	(2) 8 ft. (1) 16 ft.*
VOLTAGE OPEN	24.2 VDC		



Component of a complete system including: Aion LED A-Track Light Engine, Aion LED A-Track housing with diffuser lens, & Aion LED driver (power supply). Dimmer not included. Approved dimmers, controls, power supplies, cable, & other components only. Contact Aion LED for questions regarding compatibility. Electrician installed. Strictly adhere to NEC & local building code. Limited 5-year warranty against manufacturing defects only, does not cover labor; voided by: inadequate ventilation, field modifications, installation by unqualified personnel, unapproved controls, drivers, cabling, other devices, not following installation guidelines & protocol, general negligence. Installer assumes all liability with regard to property & safety. This product is UL listed. See separate "Aion LED Warranty Terms" & additional instructional materials for more information. Authorized installers only. Systems tested prior to shipping.

AX5-2
Compact DMX Controller

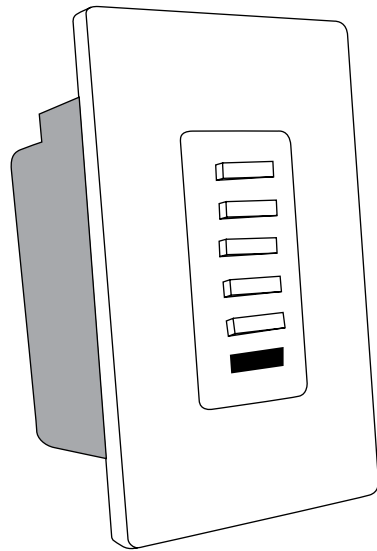

AX5 ships pre-programmed to factory default settings per application

Standard Decora™ Mounting

Optional programming software, USB interface & remote control available

Requires Approved DMX Signal Cable, Including Belden 9841 -Sold Separately

Requires D12-M-24 Power Supply

MODEL	AX5-2
DIMENSIONS (L-W-H)"	1.8 x 1.8 x 4.1"
WEIGHT	2.9 oz
POWER	2- POSITION SPRING CLIP TERMINAL
DMX PORT	3- POSITION REMOVABLE TERMINAL BLOCK
INPUT	24 VDC

Component of a complete system including: Aion LED A-Track Light Engine, Aion LED A-Track housing with diffuser lens, & Aion LED driver (power supply). Dimmer not included. Approved dimmers, controls, power supplies, cable, & other components only. Contact Aion LED for questions regarding compatibility. Electrician installed. Strictly adhere to NEC & local building code. Limited 5-year warranty against manufacturing defects only, does not cover labor; voided by: inadequate ventilation, field modifications, installation by unqualified personnel, unapproved controls, drivers, cabling, other devices, not following installation guidelines & protocol, general negligence. Installer assumes all liability with regard to property & safety. This product is UL listed. See separate "Aion LED Warranty Terms" & additional instructional materials for more information. Authorized installers only. Systems tested prior to shipping.

Aion LED Low-Voltage Class 2/3 Power Cable Dynamic White System

UL Approved
UV Rated
Indoor/ Outdoor

Fixture Power Lead

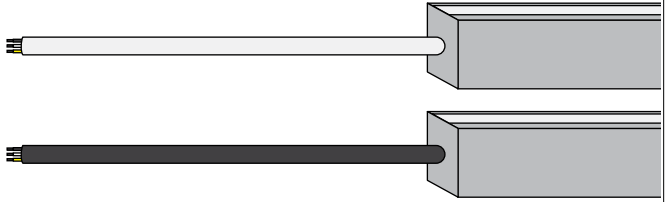
FIXTURE POWER LEAD	WHITE JACKET	BLACK JACKET	
12" power lead	CT-A12	CTB-A12	
24" power lead	CT-A24	CTB-A24	
48" power lead	CT-A48	CTB-A48	

Hard Wire Jumper- Recommended with WR Type & LE Applications Only

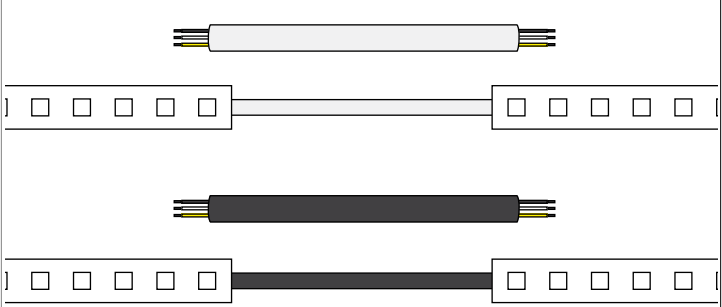
HARD WIRED JUMPER	WHITE JACKET	BLACK JACKET	
4" Hard Wired Jumper	CT-C4	CTB-C4	
12" Hard Wired Jumper	CT-C12	CTB-C12	
24" Hard Wired Jumper	CT-C24	CTB-C24	

3 Pin Plugs- Recommended with all AT Series Housings & Fixtures

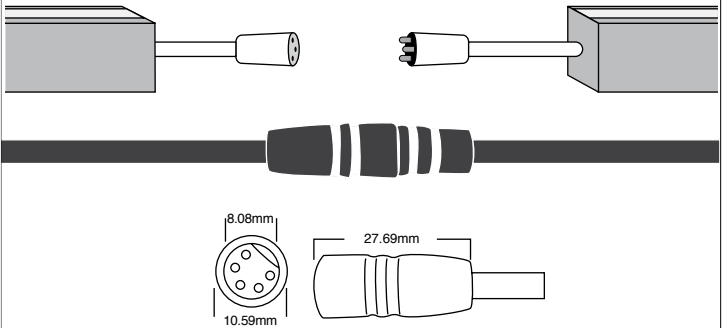
3 PIN JUMPER w/ disconnect	WHITE JACKET	BLACK JACKET	
4" Jumper with Disconnect	CT-BP4	CT-BPB4	
12" Jumper with Disconnect	CT-BP12	CT-BPB12	
24" Jumper with Disconnect	CT-BP24	CT-BPB24	
48" Jumper with Disconnect	CT-BP48	CT-BPB48	



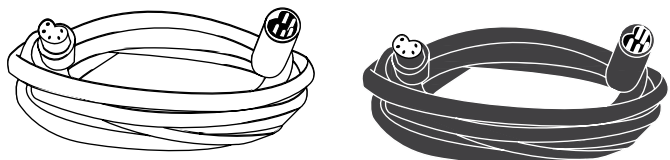

Patch Cord- Optional, to Extend Length

PATCH CORD	WHITE JACKET	BLACK JACKET	
24" M to F Extension Cord	BP-5FM24	BPB-5FM24	
48" M to F Extension Cord	BP-5FM48	BPB-5FM48	
96" M to F Extension Cord	BP-5FM96	BPB-5FM96	

Black standard for dark bronze housings
White standard for silver housings

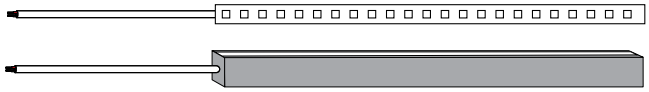
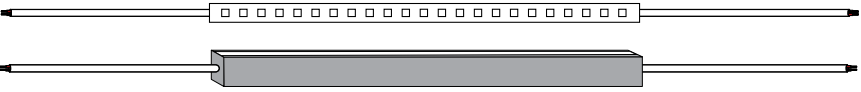
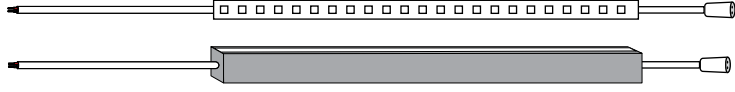
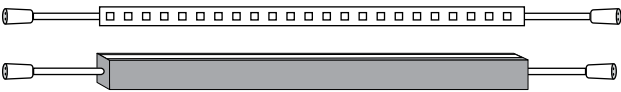
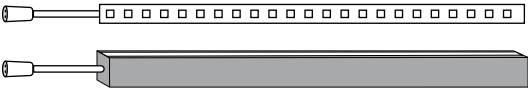

Unless Otherwise Noted, Leads are 24" and Plugs are 4". Other Lengths Available

- CONFIGURATION 1**
 Power Lead to Fixture
Default, Unless Otherwise Noted

- CONFIGURATION 2**
 Power Lead to Fixture with End Lead
 
- CONFIGURATION 3**
 Power Lead to Fixture with End Plug
 
- CONFIGURATION 4**
 Power Plug to Fixture with End Plug
 
- CONFIGURATION 5**
 Power Plug to Fixture
 
- CONFIGURATION 6**
Not Compatible with Track
 Power Lead to Fixture with Jumper to Next Fixture
 
- CONFIGURATION 7**
Not Compatible with Track
 Jumper to Fixture with Jumper to Next Fixture
 
- CONFIGURATION 8**
Not Compatible with Track
 Jumper to Fixture
 

A-TRACK FIXTURES

Pre-assembled: ≤ 8 ft (96 in)

Assembly Required: > 8 ft (96 in)



Component of a complete system including: Aion LED A-Track Light Engine, Aion LED A-Track housing with diffuser lens, & Aion LED driver (power supply). Dimmer not included. Approved dimmers, controls, power supplies, cable, & other components only. Contact Aion LED for questions regarding compatibility. Electrician installed. Strictly adhere to NEC & local building code. Limited 5-year warranty against manufacturing defects only, does not cover labor; voided by: inadequate ventilation, field modifications, installation by unqualified personnel, unapproved controls, drivers, cabling, other devices, not following installation guidelines & protocol, general negligence. Installer assumes all liability with regard to property & safety. This product is UL listed. See separate "Aion LED Warranty Terms" & additional instructional materials for more information. Authorized installers only. Systems tested prior to shipping.



NAME	LOCATION	SPECIFIER
------	----------	-----------

HOUSING	 AT SERIES HOUSING - LENS - FINISH			<h3>Required Fixture Lengths</h3> <p>Please input fixture lengths/ quantity & configuration types</p> <table border="1"> <thead> <tr> <th>ZONE</th> <th>LENGTH</th> <th>QUANTITY</th> <th>CONFIGURATION TYPE</th> </tr> </thead> <tbody> <tr><td> </td><td> </td><td> </td><td> </td></tr> <tr><td> </td><td> </td><td> </td><td> </td></tr> <tr><td> </td><td> </td><td> </td><td> </td></tr> <tr><td> </td><td> </td><td> </td><td> </td></tr> <tr><td> </td><td> </td><td> </td><td> </td></tr> <tr><td> </td><td> </td><td> </td><td> </td></tr> <tr><td> </td><td> </td><td> </td><td> </td></tr> <tr><td> </td><td> </td><td> </td><td> </td></tr> <tr><td> </td><td> </td><td> </td><td> </td></tr> </tbody> </table>	ZONE	LENGTH	QUANTITY	CONFIGURATION TYPE																																				
	ZONE	LENGTH	QUANTITY		CONFIGURATION TYPE																																							
 8 0 1 8 0 2 8 4 5			<input type="checkbox"/> Frosted <input type="checkbox"/> Prismatic <input type="checkbox"/> Clear	<input type="checkbox"/> Silver (Standard-leave blank) <input type="checkbox"/> Dark Bronze																																								
LIGHT ENGINE	8924 - CT3022 - LE			<p>Notes</p> <p>Refer to Light Engine Data Sheets for Light Engine Increments. Track is cut to exact length (1/8" tolerance) Allow tolerance for wiring/ plugs Fixtures up to Class 2 max. length</p> <p>Custom Lengths</p> <p>Fully assembled up to ≤ 8 ft. (96 in). Fixtures > 8 ft. (96 in) may require assembly at the job site.</p>																																								
	POWER LEADS JUMPER W/ DISCONNECT PLUGS HARD WIRED JUMPERS																																											
LEADS	<input type="checkbox"/> CT-A24 White 24" <input type="checkbox"/> CTB-A24 Black 24" <input type="checkbox"/> CT-A Custom			REFERENCE LEADS & PLUGS CONFIGURATION TYPES PAGE																																								
	<input type="checkbox"/> CT-BP4 White <input type="checkbox"/> CT-BPB4 Black <input type="checkbox"/> CT-BP Custom																																											
DRIVER	<input type="checkbox"/> X DMX, 2 CHANNEL <input type="checkbox"/> AX5 DMX CONTROLLER <input type="checkbox"/> DYNAMIC TUNER MODULE & IOS APP			<p>SIGNATURE (Required if Final Lengths)</p> <input type="checkbox"/> Final Order Lengths* <input type="checkbox"/> Budgetary only, requires field verification																																								
	<input type="checkbox"/> D100-X2 <input type="checkbox"/> AX5-2 <input type="checkbox"/> D12-M <input type="checkbox"/> DTM																																											

Component of a complete system including: Aion LED A-Track Light Engine, Aion LED A-Track housing with diffuser lens, & Aion LED driver (power supply). Dimmer not included. Approved dimmers, controls, power supplies, cable, & other components only. Contact Aion LED for questions regarding compatibility. Electrician installed. Strictly adhere to NEC & local building code. Limited 5-year warranty against manufacturing defects only, does not cover labor; voided by: inadequate ventilation, field modifications, installation by unqualified personnel, unapproved controls, drivers, cabling, other devices, not following installation guidelines & protocol, general negligence. Installer assumes all liability with regard to property & safety. This product is UL listed. See separate "Aion LED Warranty Terms" & additional instructional materials for more information. Authorized installers only. Systems tested prior to shipping.